

# TOP MOUNT FLIP TARP ASSEMBLY FOR BELLY DUMP TRAILERS WITH CLOCK SPRING UNDERBODY MANUAL & ELECTRIC

## SMOOTH ROLLER BOX 96" ELECTRIC ASSEMBLY

96"

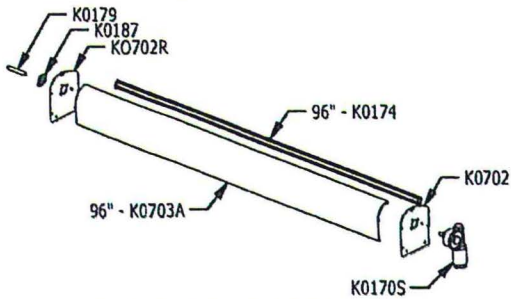

## TREAD ROLLER BOX MANUAL ASSEMBLY

96"

102"

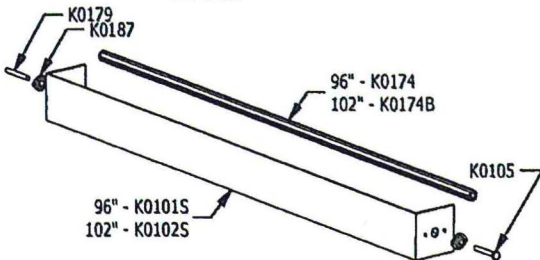

## CHAIN AND GEARBOX ASSEMBLY

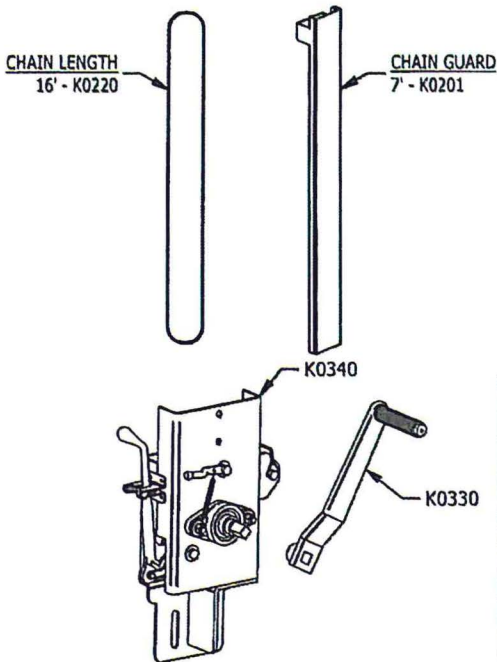

## ARM AND CROSSOVER ASSEMBLY

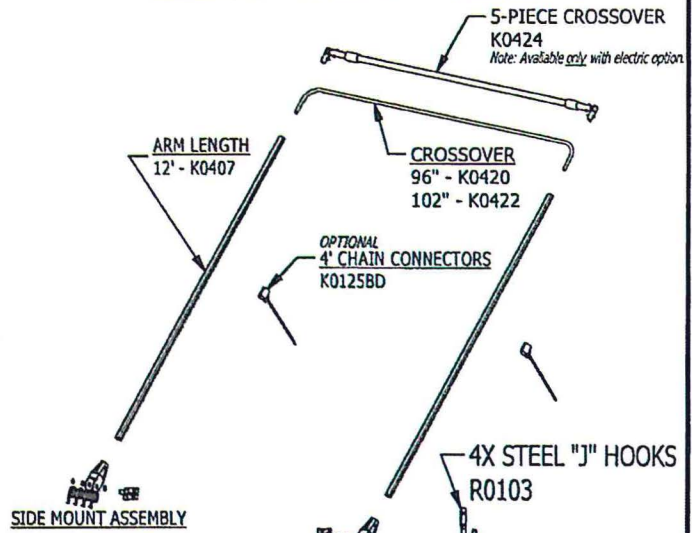

## CLOCK SPRING ATTACHMENT

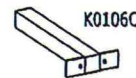

## GEARBOX HOLDER



## DOUBLERS

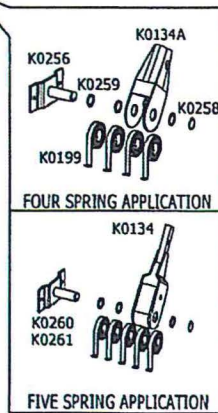
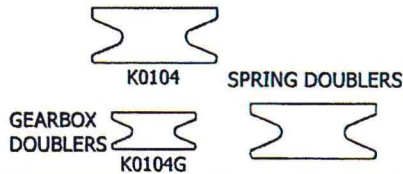

## OPTIONS

<b>PIVOT PIN</b> <input type="checkbox"/> K0526 - FOUR SPRING APPLICATION <input type="checkbox"/> K0527 - FIVE SPRING APPLICATION		<b>5-SPRING SIDE MOUNT ASSEMBLY</b> <input type="checkbox"/> K0260 - DRIVER <input type="checkbox"/> K0261 - PASSENGER	
<b>WIRELESS REMOTE</b> <input type="checkbox"/> MPW1000	<b>4 SPRING COVER</b> <input type="checkbox"/> K0134AC	<b>4' CHAIN CONNECTORS</b> <input type="checkbox"/> K0125BD	<b>FIVE PIECE CROSSOVER</b> ELECTRIC OPTION ONLY <input type="checkbox"/> K0424

PART #	KIT DESCRIPTION	PRICE	PART #	KIT DESCRIPTION	PRICE
K612BCM	BELLY DUMP CS MANUAL 96"		K012BCM	BELLY DUMP CS MANUAL 102"	
K612BCE	BELLY DUMP CS ELECTRIC 96"		K012BCE	BELLY DUMP CS ELECTRIC 102"	